

Kopieren / Profildrehen mit 47°

Geeignet ab Bohrungsdurchmesser 7,0 mm.

Copying / Profiling with 47°

For use in bores as of minimum bore diameter 7,0 mm.

Schnittwerte (Start) // Cutting parameters (start)

f **0,02 mm/U** Vc **Seite/Page 429**

Passende Klemmhalter auf Seite // Suitable toolholders on page

153, 154, 155, 156, 157, 158, 159, 160, 161, 162, 163, 164



Legende **213**
Legend



Oder besuchen Sie // Or Visit
www.simtek.info/cp/814

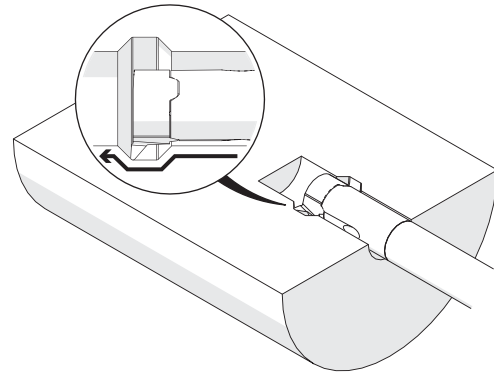
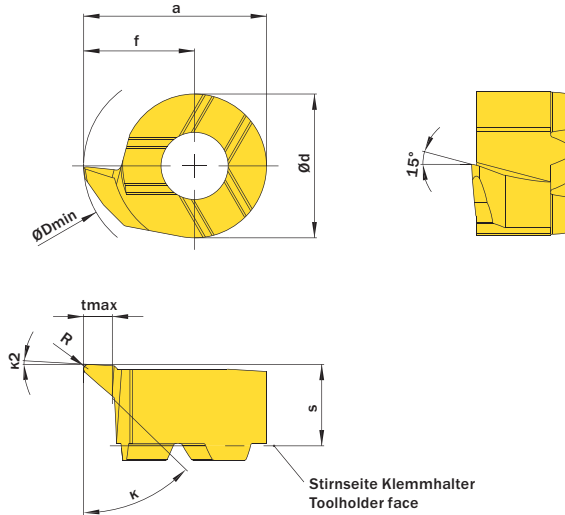

Abbildung zeigt / Drawing shows: D08.4746.02 Y R

ØDmin (Min. Bohrung) ØDmin (min. bore)	κ	κ2	f	R	Artikelnummer Part number	Webcode www.simtek.com/webcode	Unsere erste Wahl Our first choice				a	Ød	S	tmax	Connectcode www.simtek.com/code
							P	K	M	S					
▼ ØDmin (Min. Bohrung) // ØDmin (min. bore) = 7,0 mm															
7,0	47°	3°	4,15	0,2	D07.4746.02 YR/L	R AVQU L AXBB	X800	X400		6,55	4,8	3,7	1,2	D07	
▼ ØDmin (Min. Bohrung) // ØDmin (min. bore) = 7,8 mm															
7,8	47°	3°	4,65	0,1	D08.4746.01 YR/L	R AX66 L AX67	X800	X400		7,65	6,0	3,5	1,2	D08	
7,8	47°	3°	4,65	0,2	D08.4746.02 YR/L	R AKYF L AJ2X	X800	X400		7,65	6,0	3,5	1,2	D08	
7,8	47°	3°	4,65	0,4	D08.4746.04 YR/L	R AS6C L AS6D	X800	X400		7,65	6,0	3,5	1,2	D08	
▼ ØDmin (Min. Bohrung) // ØDmin (min. bore) = 9,0 mm															
9,0	47°	3°	5,5	0,2	D09.4755.02.09 YR/L	R AWGJ L AWHZ	X800	X400		8,6	6,2	3,6	1,5	D09	
▼ ØDmin (Min. Bohrung) // ØDmin (min. bore) = 10,0 mm															
10,0	47°	3°	5,8	0,2	D10.4758.02.10 YR/L	R AD29 L AJQD	X800	X400		9,3	7,0	3,9	1,8	D10	
▼ ØDmin (Min. Bohrung) // ØDmin (min. bore) = 11,0 mm															
11,0	47°	3°	6,7	0,2	D11.4767.02 YR/L	R AENC L AA5D	X800	X400		10,7	8,0	4,2	2,3	D11	
11,0	47°	3°	6,7	0,4	D11.4767.04 YR	A232	X800	X400		10,7	8,0	4,2	2,3	D11	
▼ ØDmin (Min. Bohrung) // ØDmin (min. bore) = 13,7 mm															
13,7	47°	3°	8,7	0,2	D14.4787.02 YR/L	R AB9M L ACMV	X800	X400		13,2	9,0	5,3	4,0	D14	
13,7	47°	3°	8,7	0,4	D14.4787.04 YR	A232	X800	X400		13,2	9,0	5,3	4,0	D14	
▼ ØDmin (Min. Bohrung) // ØDmin (min. bore) = 15,8 mm															
15,8	47°	3°	10,2	0,2	D16.4702.02 YR/L	R AEPV L APDF	X800	X400		15,7	11,0	5,4	4,3	D16	
▼ ØDmin (Min. Bohrung) // ØDmin (min. bore) = 16,0 mm															
16,0	47°	3°	11,0	0,2	D14.4710.02 YR/L	R ANK4 L AAN6	X800	X400		15,5	9,0	5,2	5,0	D14	
▼ ØDmin (Min. Bohrung) // ØDmin (min. bore) = 18,0 mm															
18,0	47°	3°	12,0	0,2	D18.4712.02.18 YR/L	R ADMT L ANKX	X800	X400		17,5	11,0	5,6	6,0	D18	
▼ ØDmin (Min. Bohrung) // ØDmin (min. bore) = 20,0 mm															
20,0	47°	3°	14,0	0,2	D18.4714.02.20 YR/L	R AE0B L ABFF	X800	X400		19,5	11,0	5,6	8,0	D18	

Bestellbeispiel // Order example: **D09.4755.02.09 YR X800** (R = Rechte Ausführung // Right hand version, X800 = Schneidstoff // Grade)